

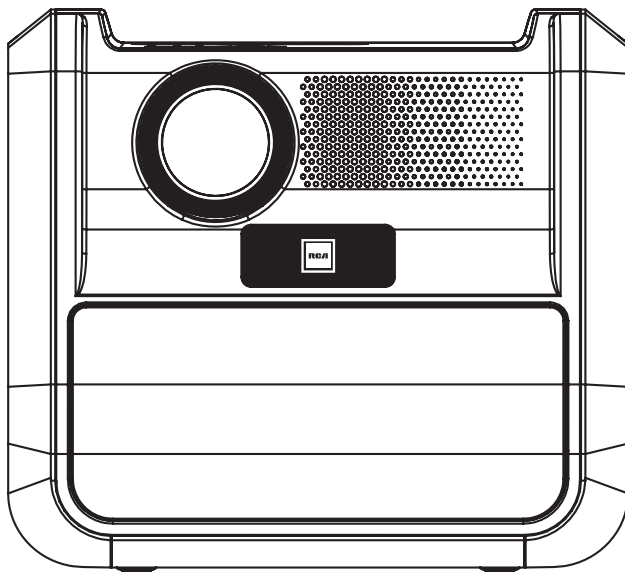

MODEL NO. **RPJ060**

PORTABLE PROJECTOR ENTERTAINMENT SYSTEM

INSTRUCTION MANUAL



PLEASE READ BEFORE OPERATING THIS EQUIPMENT

This product is manufactured and sold by Curtis International Ltd. RCA, the RCA logo, the two dogs (Nipper and Chipper) logo, are registered trademarks or trademarks of RCA Trademark Management and are used under license by Curtis International Ltd. Any other product, service, company, trade or product name and logo referenced herein are neither endorsed nor sponsored by RCA Trademark Management or its affiliates.

Ideal for dark viewing environments for optimal performance.

Please note: Projector brightness is measured in ANSI lumens.

Your viewing environment is the deciding factor on how many lumens your projector needs.

Important Safety Instructions

1. Read these Instructions.
2. Keep these Instructions.
3. Heed all Warnings.
4. Follow all instructions.
5. Do not use this apparatus near water.
6. Clean only with a dry cloth.
7. Do not block any ventilation openings. Install in accordance with the manufacturer's instructions.
8. Do not install near any heat sources such as radiators, heat registers, stoves, or other apparatus (including amplifier) that product heat.
9. Protect the power cord from being walked on or pinched particularly at plugs, convenience receptacles, and the point where they exit from the apparatus.
10. Only use attachments/accessories specified by the manufacturer.
11. Unplug this apparatus during lightning storms or when unused for long periods of time.
12. Refer all servicing to qualified service personnel. Servicing is required when the apparatus has been damaged in any way, such as power-supply cord or plug is damaged, liquid has been spilled or objects have fallen into the apparatus, the apparatus has been exposed to rain or moisture, does not operate normally, or has been dropped.
13. Use only with a cart, stand, tripod, bracket, or table specified by the manufacturer or sold with the apparatus. When a cart is used, use caution when moving the cart/ apparatus combination to avoid injury from tip-over.



Additional Warnings and Precautions

1. Do not look directly into the projector light.
2. **Don't touch the project lens**
3. Mains adapter is used as disconnect device and it should remain readily operable during intended use. In order to disconnect the apparatus from the mains completely, the mains plug should be disconnected from the mains socket outlet completely.
4. **CAUTION:** Use of controls or adjustments or performance of procedures other than those specified may result in hazardous radiation exposure.
5. **WARNING:** Changes or modified to this unit not expressly approved by the party responsible for compliance could void the user's authority to operate the equipment.
6. **WARNING:** Use of this unit near fluorescent lighting may cause interference regarding use of the remote. If the unit is displaying erratic behavior move away from any fluorescent lighting, as it may be the cause.
7. **WARNING:** Shock hazard - Do Not Open.
8. Caution and marking information is located at the rear or bottom of the apparatus.
9. **WARNING:** To reduce the risk of fire or electric shock, do not expose this apparatus to rain, moisture, dripping, or splashing.
10. Objects filled with liquids, such as vases, shall not be placed on the apparatus.

FCC Warning

This device complies with Part 15 of the FCC rules. Operation is subject to the following two conditions: (1) this device may not cause harmful interference, and (2) this device must accept any interference received, including interference that may cause undesired operation.

NOTE: This equipment has been tested and found to comply with the limits for a Class B digital device, pursuant to Part 15 of the FCC Rules. These limits are designed to provide reasonable protection against harmful interference in a residential installation. This equipment generates, uses, and can radiate radio frequency energy and, if not installed and used in accordance with the instructions, may cause harmful interference to radio communications. However, there is no guarantee that interference will not occur in a particular installation. If this equipment does cause harmful interference to radio or television reception, which can be determined by turning the equipment off and on, the user is encouraged to try to correct the interference by one or more of the following measures:

- Reorient or relocate the receiving antenna.
- Increase the separation between the equipment and receiver.
- Connect the equipment into an outlet on a circuit different from that to which the receiver is connected.
- Consult the dealer or an experienced radio/TV technician for help.

The equipment complies with FCC radiation exposure limits set forth for an uncontrolled environment. The equipment should be installed and operated with minimum distance 20cm between the radiator & your body.

In The Box



Remote

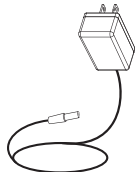

AC Power Adapter

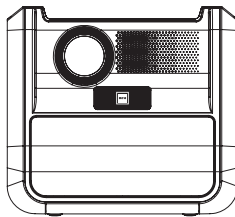

Main unit

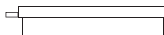

Lens Cover



User Manual

Table of Contents

Important Safety Instructions	P1
Additional Warnings and Precautions -----	P2
FCC Warning -----	P3
In The Box -----	P3
Table of Contents -----	P4
Remove & Close the Lens Cover -----	P5
Placing of Your Projector -----	P5
To Reduce Image Distortion -----	P5
Distance Between the Projector and Screen -----	P6
Adjust The Focus and Keystone -----	P6
Controls of Remote -----	P7
Install / Remove Batteries of Remote -----	P7
Controls of Projector -----	P8
Install Power Adapter -----	P9
Battery Operation (Build-in battery) -----	P9
Main Button Operation -----	P10
Connect HDMI Show The Image On Projector Screen -----	P11
Connect AV Show The Image On Projector Screen -----	P11
Connect VGA Show The Image On Projector Screen -----	P12
Connect Audio Output (Aux Out / Line Out / Earphone) -----	P13
Install USB Device -----	P13
Using USB Playback (Media Player) -----	P14
Using Bluetooth Playback -----	P15
Using Projector Menu 1 -----	P16
Using Projector Menu 2 -----	P17
Using Projector Menu 3 -----	P17
Specifications -----	P18
Warranty Card -----	P19

Remove & Close The Lens Cover

Remove the lens cover before using

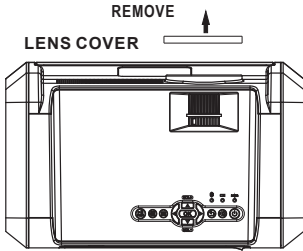

Close the lens cover when unit not using

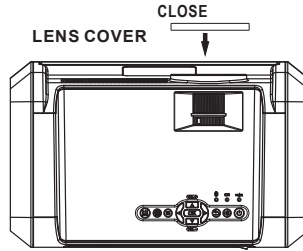

Placing of Your Projector

Your projector can be installed in four different configurations (see picture below):

Front Table



Front Table:

Select this location with the projector placed near the floor in front of the screen. This is the most common way to position the projector for quick setup and portability.

Rear Table

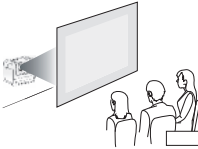

Rear Table:

Select this location with the projector placed near the floor behind the screen.

NOTE: That a special rear projection screen is required.

To Reduce Image Distortion

- Move the projector as close to the center of the screen as possible.
- The light beam from the projector should be perpendicular to the screen for a rectangular or square image.

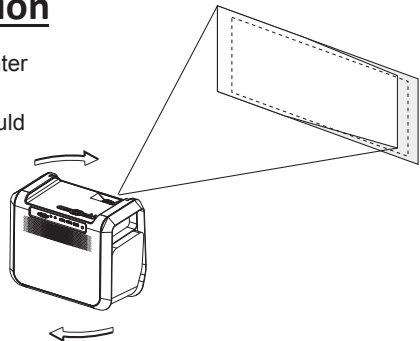

Distance Between the Projector and Screen

Measure the distance between the projector and where you want to position the screen. This is the projection distance for reference.

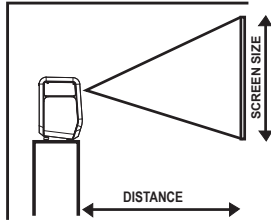

Distance	Screen Size
1.16m	37inch
1.35m	45 inch
1.51m	50 inch
1.79m	60 inch
2.15m	72 inch
2.81m	100 inch
3.43m	120 inch
4.44m	150 inch

Adjust The Focus And Keystone

Follow below picture to adjust the focus and trapezoidal screen.

Adjust the focus by turning the knob while observing the image pixels near the center of the screen. Optimal focus is obtained when the pixels are clearly visible. Depending on the projected screen size, the focus near the screen edges may be less sharp than the screen center.

Keystone image is created when the projector lens is projected from above or below the center of the screen. Keystone correction restores the distorted image to a rectangular or square shape.

KEYSTONE ADJ. KNOB

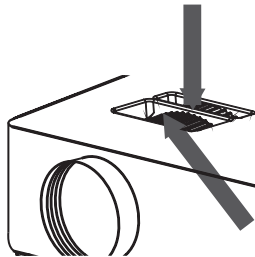

FOCUS ADJ. KNOB

Then sharpen the image by rotating focus knob.

Controls of Remote

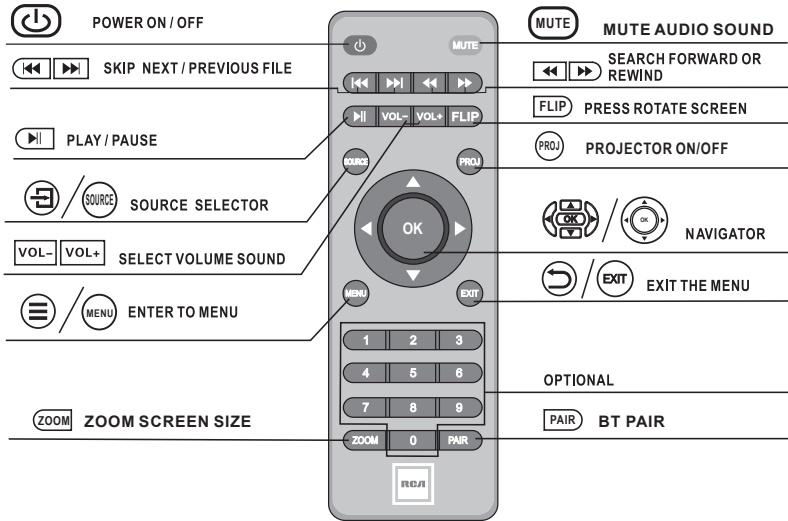

Install / Remove Batteries of Remote

Remove the battery compartment cover on the back of your remote by carefully sliding to open. The battery cover can then be lifted away. Fit the correct batteries (not included), referring to the polarity markings. Finally, replace the cover.

NOTES:

- Batteries shall not be exposed to excessive heat such as placing under the sunlight or near a fire.
- Please make sure the batteries are installed with their correct polarities.
- Do not mix old and new batteries.
- Use only the same type of batteries.
- Do not dispose of the batteries in fire, battery may explode or leak.
- Do not recharge a non-rechargeable battery.

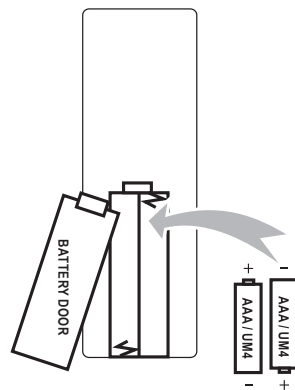

Controls of Projector

FRONT VIEW

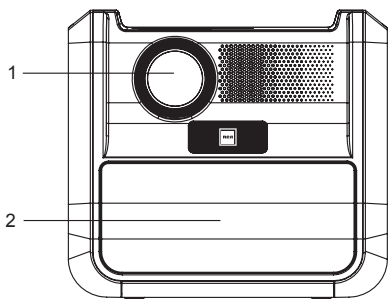

TOP VIEW

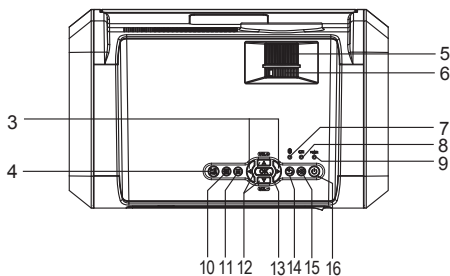

REAR VIEW

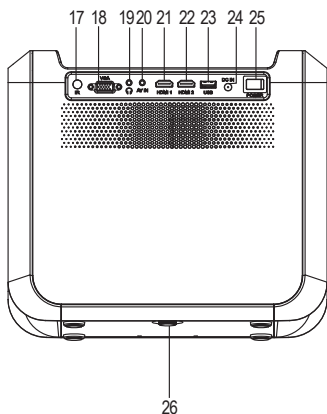



- | | | | |
|----|-----------------------|----|------------------|
| 1 | LENS | 14 | RETURN ↶ Button |
| 2 | SPEAKER | 15 | PROJECTOR Button |
| 3 | ◀/▶ Buttons | 16 | POWER ⏻ Button |
| 4 | ▶▶ / PAIR Button | 17 | IR Sensor |
| 5 | FOCUS ADJ. Knob | 18 | VGA Port |
| 6 | TRAPEZOIDAL ADJ. Knob | 19 | Headphone Jack |
| 7 | BT indicator | 20 | AV IN Jack |
| 8 | BATTERY Indicator | 21 | HDMI 1 Port |
| 9 | POWER Indicator | 22 | HDMI 2 Port |
| 10 | SOURCE +⏏ Button | 23 | USB Port |
| 11 | MENU ≡ Button | 24 | DC IN Jack |
| 12 | VOL+▲ / VOL-▼ Buttons | 25 | POWER Switch |
| 13 | Ⓚ Button | 26 | ANGEL ADJ. Knob |

Install Power Adapter

Follow below picture to connect power adapter

Plug the included AC adapter body into the standard AC power outlet to power the unit. Connect small end to **DC IN** jack of main unit.

After that, press the **POWER** switch to on position to turn the unit in standby model, the  indicator is lighted red.

To turn on the unit, press  button once on unit panel or by the remote. The  indicator is lighted green.

WARNING:

Before connecting to the power supply, ensure that the supply corresponds to the information on the rating label at the back of the apparatus.

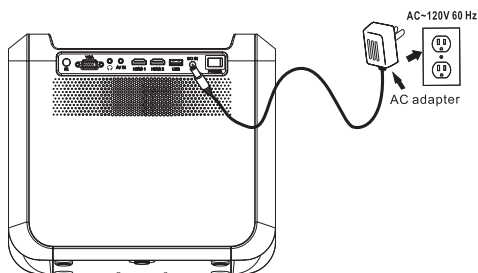

➤ **Charging Battery**

1. Charging the built-in battery by connect small end of adapter into DC IN jack at the rear of the unit and plug adapter body to AC wall outlet.
2. When the built-in battery charging now, the charging indicator light RED.
3. If the charging indicator is light GREEN that the built-in battery fully charging. Unplug the output of adapter from the DC IN jack once the battery is fully charged.

➤ **Battery Safety Notes:**

1. To prolong the life of a rechargeable battery, it is recommended to completely discharge it before fully charging it again.
2. Do not dispose of built-in battery in fire, battery may be explode or leak.
3. Do not open the built-in battery may be explode.

Battery Operation (Build-in battery)

For battery operation, unplug the adapter from the AC wall outlet first and then remove the DC plug from the DC IN jack at the rear of the unit.

Caution:

When the unit is intended to unused for a long period of the time, please press **POWER SWITCH** to **OFF** position to turn off the unit and unplug the power adapter from the AC wall outlet.

Main Button Operation

 - Press the button to turn on unit, press again to standby mode.

 / **SOURCE** - Press the button to select input source.

 / **MENU** - Press the button to enter projector menu.

 - Press the buttons to navigate and select screen item of menu.

 / **EXIT** - Press the button to return to previous status or exit the menu.

 - Press the buttons to fast search forward and rewind on USB.

 - Press the buttons to search next or previous file on USB.

VOL+ / VOL - Press the buttons to select the sound level.

 - Press the button to play/pause the playback of file on USB.

FLIP - Press the button to rotate / mirror projector screen

ZOOM - Press the button to select image scale.







PROJ - Press the button to On / Off the projector function.

PAIR - Press the button to Pair or Unpair the bluetooth connection

MUTE - Press to mute the audio. Press again to resume.

Connect HDMI Show The Image On Projector Screen

Refer to the following picture to connect a set top box, a BD/DVD player or a streaming player to the HDMI input.

1. Turn the unit to standby mode before connect HDMI cable.
2. After connection, press the  button to turn on unit and  indicator will light GREEN.
3. Press the **PROJECTOR** button to turn on the projector function.
4. Press the  / SOURCE button, use the  /  button to select HDMI and press  button to enter. The video from the connected device will be shown on projector screen.
5. Press the  button to turn the unit to standby mode.

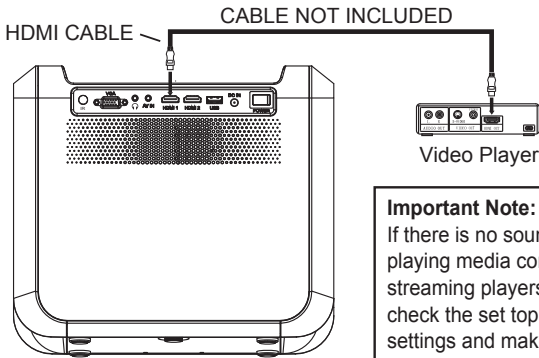







Important Note:

If there is no sound from the internal speakers when playing media contents from a set top box, BD/DVD or streaming players connecting to the HDMI input, please check the set top box or the player's digital audio settings and make sure it is set to "PCM Stereo" mode.

Connect AV Show The Image On Projector Screen





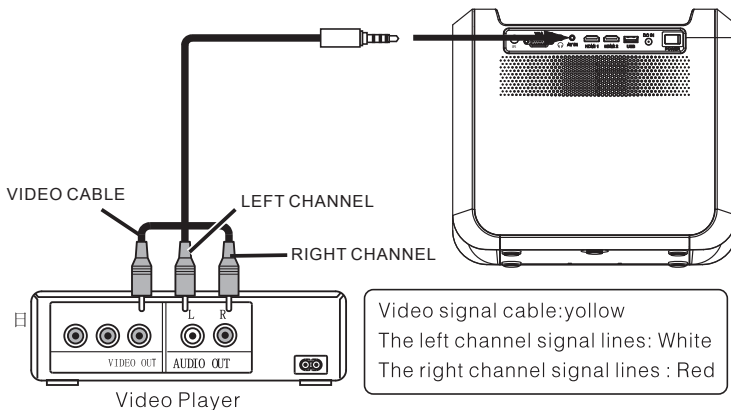

Follow below picture to connect AV cable and device.

1. Turn the unit to standby mode before connect AV cable.
2. After connect, press the  button to turn on unit and power indicator will light GREEN
3. Press the **PROJECTOR** button to turn on the projector function.
4. Press the  / SOURCE button, use the  /  button to select AV and press  button to enter. The video of AV device will show on projector screen
5. Press the  button to turn the unit to standby mode.



Connect VGA Show The Image On Projector Screen

Follow below picture to connect VGA cable and device.

1. Turn the unit to standby mode before connect VGA cable.
2. After connect, press the  button to turn on unit and power indicator will light GREEN
3. Press the PROJECTOR button to turn on the projector function
4. Press the  / SOURCE button, use the  /  button to select VGA and press  button to enter. The video of VGA device will show on projector screen
5. Press the  button to turn the unit to standby mode.

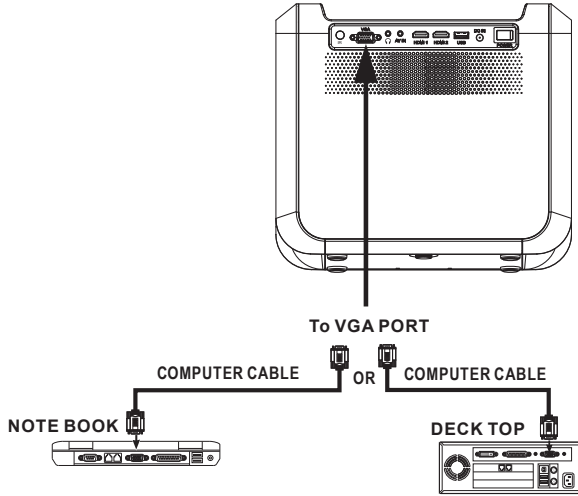

Please refer to the following table to adjust the output signal from computer

Type	Resolution		Frequency	Field Frequency
PC	VGA	640x480	31.5	60
			34.7	70
			37.9	72
			37.5	75
	SVGA	800x600	31.4	50
			35.1	56
			37.9	60
			46.6	70
			48.1	72
	XGA	1024x768	46.9	75
			40.3	50
			48.4	60
56.5			70	

NOTE: In order to get the sound from the unit, please connect AV IN cable when you connect VGA input.

Connect Audio Output (Aux Out / Line Out / Earphone)

Follow below picture to connect audio cable and device.

1. Press the  button to turn the unit in standby mode before connection.
2. Use audio cable to connect follow below figure.
3. After connect and turn on both units. Your projector sound from external device now.
4. After using , turn off both unit

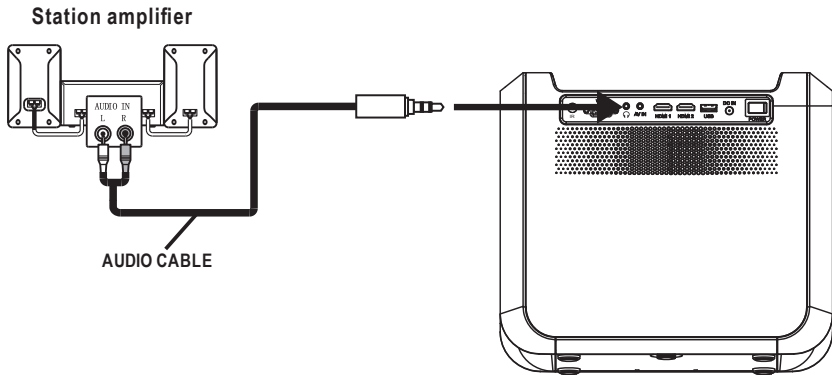

Important Note:

If there is no sound from the stereo audio output when playing media contents from a set top box, BD/DVD or streaming players connecting to the HDMI input, please check the set top box or the player's digital audio settings and make sure it is set to "PCM Stereo" mode.

Install USB Device





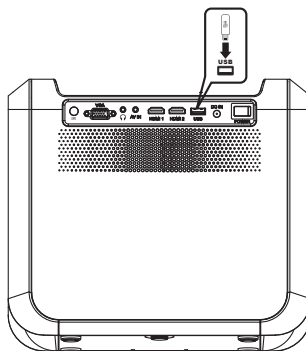













Follow below picture to install USB

Press the  button to turn unit to standby mode before install USB.



Using USB Playback (Media Player)























Install USB device:

1. Press **PROJECTOR** Button to turn off projector function before install USB.
2. Install the USB device into USB port.
3. After connect, press the **PROJECTOR** button to turn on unit
4. Press the  / **SOURCE** button to enter, use  /  buttons to select **Media Player** and press the  button to enter.
5. After that, the Media Player menu will display, use  /  buttons to select one of the icon of PHOTO / MUSIC / MOVIE / TEXT and press the  button to enter.
6. Use the  /  button to select USB and press  button to enter.
7. Use  /  buttons to search the correct file and press the  button to preview playback file and press  button of remote to start playback.
8. Press  /  button to fast search forward and rewind.
9. Press  /  button to search next or previous file.
10. During playback, press the  button to pause and press again to resume.

NOTE:

If USB no name, the unit default it as C

To remove USB, press the  button to turn the unit in standby mode **FIRST**.







Sub-Menu on Photo screen	
<ol style="list-style-type: none"> 1. When photo playback, press the  button and more function screen show on lower (figure 1). 2. Use the  /  button to select icon and press the  button to play special function. 	 
Sub-Menu on Music screen	
<ol style="list-style-type: none"> 1. When photo playback, press the  button and more function screen show on lower (figure 2). 2. Use the  /  button to select icon and press the  button to play special function. 	 
Sub-Menu on Movie screen	
<ol style="list-style-type: none"> 1. When photo playback, press the  button and more function screen show on lower (figure 3). 2. Use the  /  button to select icon and press the  button to play special function. 	 
Sub-Menu on Text screen	
<ol style="list-style-type: none"> 1. When photo playback, press the  button and more function screen show on lower (figure 4). 2. Use the  /  button to select icon and press the  button to play special function. 	

Using Bluetooth Playback

External devices that have a built-in Bluetooth feature can connect wirelessly to the **Unit**.

Getting Connected

Pairing a Bluetooth device



1. Press the  button to turn on unit, the power indicator light GREEN
2. Press the  / **SOURCE** button, use the  /  button to select Bluetooth and press  button to enter Bluetooth mode and Bluetooth  indicator will flash Blue.
3. The Bluetooth function of your external device to ON and begin searching for devices.

NOTE: The effective distance between your external device and this apparatus is 10 meters (30 feet)

4. Select "RCA RPJ060" from the device list when it appears on your device screen.
5. If you are asked for a password, enter "0000"
6. An audible chime will sound and Bluetooth indicator is lighted blue steadily that indicates a connection has been established. The screen will show "Connected"
7. A few seconds later your Bluetooth connection should be ready to use.
8. If you want change to pair with another Bluetooth Enable Device. Press and hold the **PAIR** button. The Bluetooth  indicator will flash blue, the screen will show "No Connect" and the unit will go into Pairing / Discoverable mode again.

*Note: After initial pairing, the unit will stay paired unless unpaired manually by the user or erased due to a reset of the device. If your device should become unpaired or your find it is unable to connect, repeat the above steps or press and hold the Bluetooth **PAIR** button again*

Playing Music from an External Bluetooth Device

1. After pair your external device and set it to play.
2. Turn on the music player program on your external device and set it to play.
3. Audio played through the connected Bluetooth Device will now be heard through the speakers.
4. Press the play/pause  button on the remote or short press the play/pause  button on unit to pause or resume play.
5. Also can use  button to select previous or next file on external device.
6. If you select ECO mode, the unit will turn off the project function. To resume, press PROJECTOR button once.
7. Press VOL+ or VOL- button to obtain the desired volume level.

Using Projector Menu 1

Press  /MENU button to enter projector menu **Picture** menu.

Picture Mode Medium
 Color Temperature Medium
 Aspect Ratio 16:9
 Noise Reduction Middle
 PC Setting
 Reduce Display Size 100%

This **Picture** menu showed on right upper of view screen.

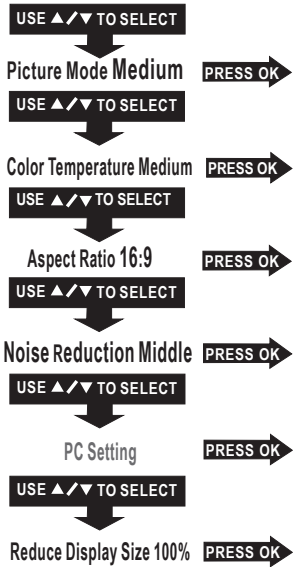

Use ◀/▶ to select different picture effect to Vivid / Medium / Soft / User. Use ◀/▶ or ▲/▼ to select Contrast / Brightness / Color / Sharpness digit If chose User item. Follow below figure.

Use ◀/▶ buttons to select different color temperature to Cool / Medium / Warm / User. Use ◀/▶ or ▲/▼ to select Red / Green / Blue digit If chose User item. Follow below figure.

Use ▲/▼ buttons to select screen ratio AUTO / 4:3 / 16:9. Follow below figure.

Use ▲/▼ buttons to select Off / Low / Middle / High / Default

Use ▲/▼ buttons to select Auto Adjust / Horizon Pos. / Vertical Pos. / Size / Phase items. Use ◀/▶ or ▲/▼ to select Horizon Pos. / Vertical Pos. / Size / Phase digit. Follow below figure.

Use ◀/▶ buttons to select different zoom scale digit 75% - 100%

Picture Mode	
Customer define	Parameter
Contrast	0-100
Brightness	0-100
Color	0-100
Sharpness	0-100

Color Temperature	
Customer define	Parameter
RED	0-100
GREEN	0-100
BLUE	0-100

Aspect Ratio	
4:3	The signal in a 4:3 aspect ratio projection image
16:9	The signal in a 16:9 aspect ratio projection image

PC Setting (Active in VGA mode)	
Customer define	Parameter
Horizon Pos.	0-100
Vertical Pos.	0-100
Size	0-100
Phase	0-100

Note: PC setting menu is activated in VGA mode only.

Using Projector Menu 2

Press **MENU** button to enter projector menu, press ◀/▶ buttons to select **Sound** menu.

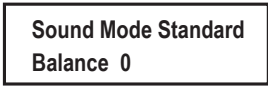

This **Sound** menu showed on right upper of view screen.

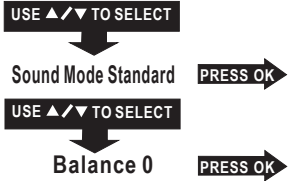

Use ◀/▶ to select different sound effect Standard / Music / Movie / Sports / User. Use ◀/▶ or ▲/▼ to select Bass and Treble digit if chose User item. Follow below figure to set digit.

Use ◀/▶ buttons to select Balance level to -50 to +50.

Sound Mode - User	Parameter
Treble	0-100
Bass	0-100

Using Projector Menu 3

Press **MENU** button to enter projector menu, press ◀/▶ buttons to select **Option** menu.

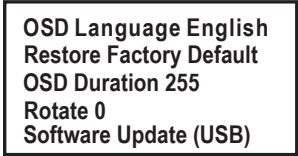

This **Option** menu showed on right upper of view screen.

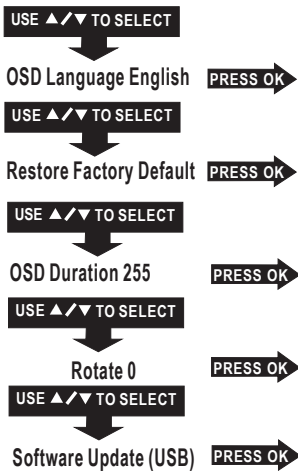

Use ◀/▶ or ▲/▼ button to select different OSD language.

Use ◀/▶ buttons to select Y or N. If choose "Y" that your unit will go to factory default setting.

Press (OK) buttons repeatedly to select different OSD Duration time off / 55 / 105 / 155 / 205 / 255 / 305.

Press (OK) buttons repeatedly to select Rotate 0 / Rotate 1 / Rotate 2 / Rotate 3.

For service center use only.

Specifications

Bluetooth Version	5.0
Light Source Type	LED
Unit ANSI Lumens	45
Display Native Resolution	800 x 480 RGB
HDMI Input Supported Video Resolution.	1080p , 1080i , 720p, 576i , 480p, and 480i
Projection Size	37-150 inch
Input Port	HDMI / USB / AUX IN / MIC IN
USB Port Supported Format	Support USB device up to 32GB Support Picture format: JPG, GIF, BMP, PNG Support Audio format: MP3 Support Video format: Mpeg1, Mpeg2, Mpeg4, RM, AVI, RMVB, MOV, MJPEG
DC IN Power	DC 13V , 4.A
Battery	Built-in Lithium Battery

Specifications are typical, individual units might vary. They are subject to continuous improvement without notice and without incurring any obligation.

For service assistance and product information, please call: 1-800-968-9853.

Pour obtenir assistance et information appelez: 1-800-968-9853.

Curtis International Ltd.

7045 BECKETT DRIVE, UNIT 15,

MISSISSAUGA, ON, L5S 2A3

www.curtisint.com

To make a warranty claim, do not return this product to the store. Please email support@curtiscs.com or call 1-800-968-9853.

90 day Warranty

This product is warranted to be free from defects in material and workmanship for a period of ninety (90) days from the date of original purchase. During this period, your exclusive remedy is repair or replacement of this product or component found to be defective, at our option; however, you are responsible for all costs associated with returning the product to us. If the product or component is no longer available, we will replace with a similar one of equal or greater value. Prior to a replacement being sent, the product must be rendered inoperable or returned to us.

This warranty does **not** cover glass, filters, wear from normal use, use not in conformity with the printed directions., or damage to the product resulting from accident, alteration, abuse, or misuse. This warranty extends only to the original consumer purchaser or gift recipient. Keep the original sales receipt, as proof of purchase is required to make a warranty claim. This warranty is void if the product is used for other than single-family household use or subjected to any voltage and waveform other than as on the specified rating on the label (e.g., 120V~60Hz).

We exclude all claims for special, incidental, and consequential damages caused by breach of express or implied warranty. All liability is limited to the amount of the purchase price. **Every implied warranty, including any statutory warranty or condition of merchantability or fitness for a particular purpose, is disclaimed except to the extent prohibited by law, in which case such warranty or condition is limited to the duration of this written warranty.** This warranty gives you specific legal rights. You may have other legal rights that vary depending on where you live. Some states or provinces do not allow limitations on implied warranties or special, incidental, or consequential damages, so the foregoing limitations may not apply to you.

For faster service, locate the model, type, and serial numbers on your appliance.